

10/100 BASE-T PULSE TRANSFORMERS

Features:

- Compatible With Various 10/100TX Transceiver Requiring 1:1 Transmit and 1:1 Receive Turn Ratio
- Operating temperature 0°C to 70°C
- Minimum interwinding breakdown voltage of 1500Vrms

Electrical Specifications @ 25°C

Part Number	Insertion Loss (dB Max)	ReturnLoss (dB min)			CMRR (dB min)	Crosstalk (dB min)		
		0.1MHz to 100MHz	0.1MHz to 30MHz	50MHz to 80MHz		0.1MHz to 100MHz	0.1MHz to 30MHz	60MHz to 80MHz
YL18-2087S	-1.0	-16	-12	-10	-38	-42	-38	-35

Schematics

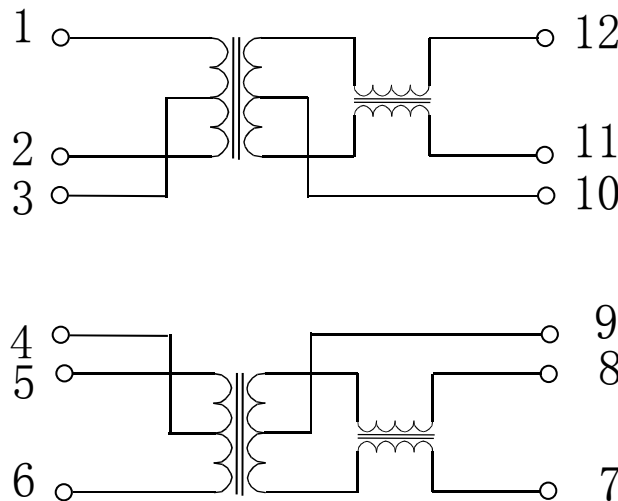

Mechanicals

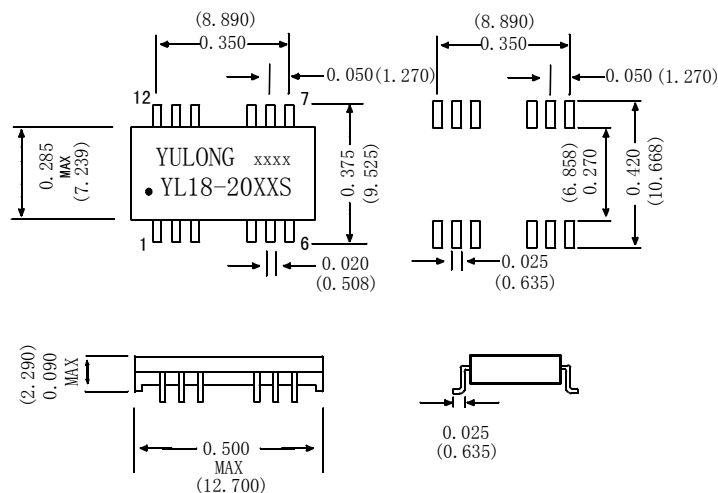

NOTE: Dimensions: inches/(mm) unless otherwise specified all tolerances are $\pm 0.010(0.25)$